



Our Focus is in Plastics

Polymer Optics Ltd.

6 Kiln Ride, Wokingham,
Berks., RG40 3JL, England
Tel/Fax: +44 (0) 1189 893341
www.polymer-optics.co.uk

Nichia 083 Series Holder – Part No. 175



- Designed for use with Polymer Optics “Modular LED Optics”[®] and other custom Polymer Optics designs
- Designed for the Nichia Rigel 083 series LEDs
- Simply mounts onto PCB and self-aligns to Nichia 083 LED
- Precision moulded in optical grade Polycarbonate for thermal stability and system durability
- Part of the Polymer Optics “Modular LED Optics”[®] range

Polymer Optics “Modular LED Optics”[®] design, based on a hexagonal format, allows maximum packing density and assembly flexibility

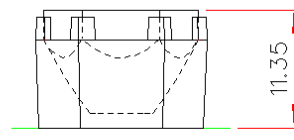
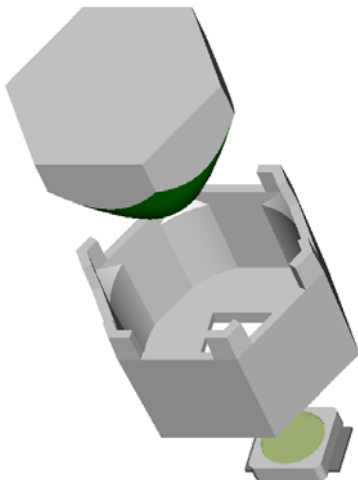

OPTIC AND HOLDER ASSY.

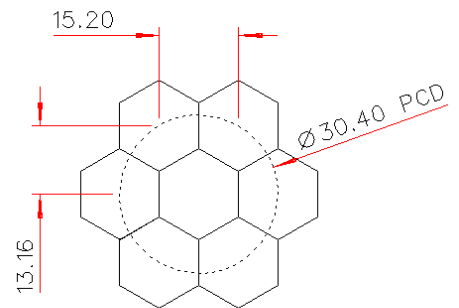
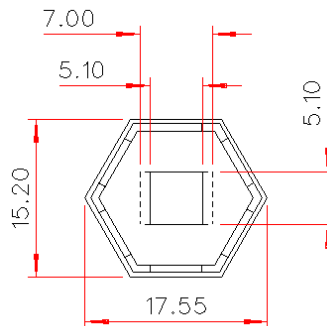

NESTED COMPONENTS ON 30.4MM PCD

Typical dimensional tolerances to +/-0.2mm

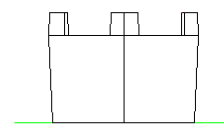
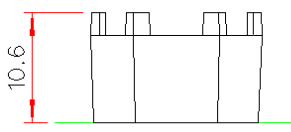



Our Focus is in Plastics

Polymer Optics Ltd.

6 Kiln Ride, Wokingham,
Berks., RG40 3JL, England
Tel/Fax: +44 (0) 1189 893341
www.polymer-optics.co.uk

6 Degree LED Collimator Lens - Part No. 120



- Designed to operate with Nichia Rigel 083 series LEDs
- High light collection efficiency of 85%
- Precision moulded in optical grade Polycarbonate for thermal stability and system durability
- Part of the Polymer Optics “Modular LED Optics”® range

Polymer Optics “Modular LED Optics”® design, based on a hexagonal format, allows maximum packing density and assembly flexibility

Supplied with Holder (Part No. 175) to mount optics directly on to PCB's. Holder locates on LED package to ensure correct alignment

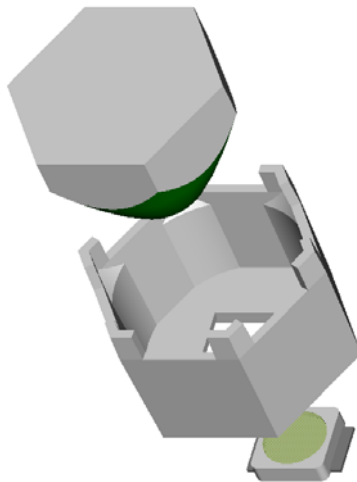

Typical dimensional tolerances to +/-0.2mm

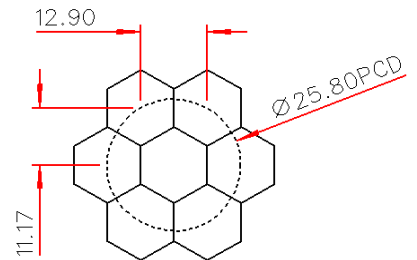
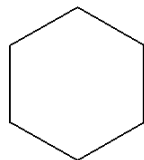

NESTED COMPONENTS ON 25,8MM PCD

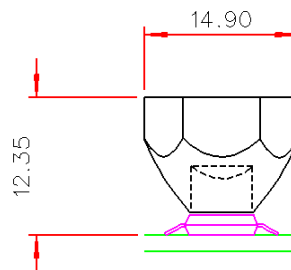
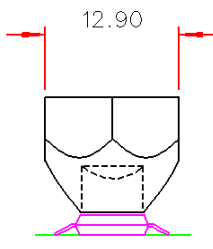



Our Focus is in Plastics

Polymer Optics Ltd.

6 Kiln Ride, Wokingham,
Berks., RG40 3JL, England
Tel/Fax: +44 (0) 1189 893341
www.polymer-optics.co.uk

LED Optics Range for Nichia 083 Series

- Designed for use with the Nichia Rigel 083 series LEDs
- High light collection efficiency of >85%
- Precision moulded in optical grade Polycarbonate for thermal stability and system durability
- Part of the Polymer Optics “Modular LED Optics”[®] range

**6 Degree LED Collimator Lens
Part No. 120**

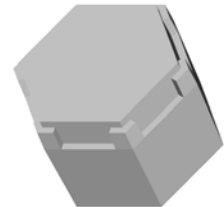

**25 Degree LED Collimator Lens
Part No. 124**

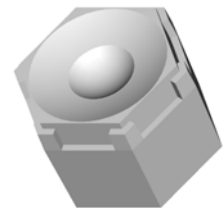

**6x25 Degree LED Collimator Lens
Part No. 126**

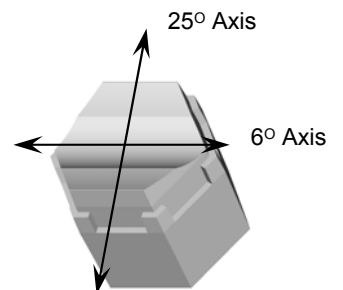
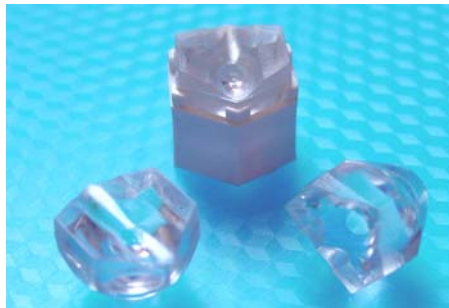



Our Focus is in Plastics

Polymer Optics Ltd.

6 Kiln Ride, Wokingham,
Berks., RG40 3JL, England
Tel/Fax: +44 (0) 1189 893341
www.polymer-optics.co.uk

LED Optics Range for Nichia 083 Series

**Single Cell LED Concentrator Lens
Part No. 141**



**6 Deg Diffuse LED Collimator Lens
Part No. 185**

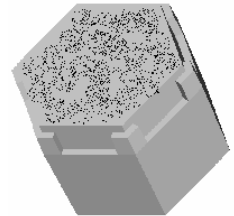
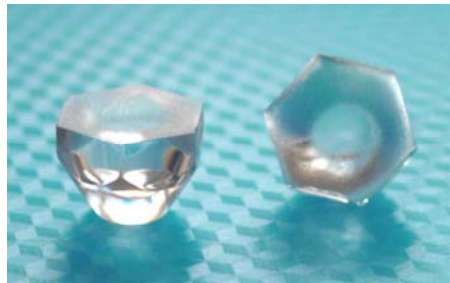

**15 Degree LED Collimator Lens
Part No. 201**

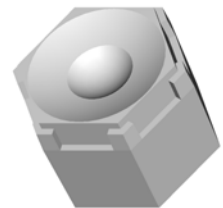



Our Focus is in Plastics

Polymer Optics Ltd.

6 Kiln Ride, Wokingham,
Berks., RG40 3JL, England
Tel/Fax: +44 (0) 1189 893341
www.polymer-optics.co.uk

LED Optics Range for Nichia 083 Series

**Diffuse 6x25 Degree LED Collimator
Part No. 216**

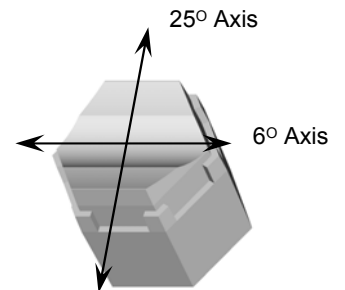
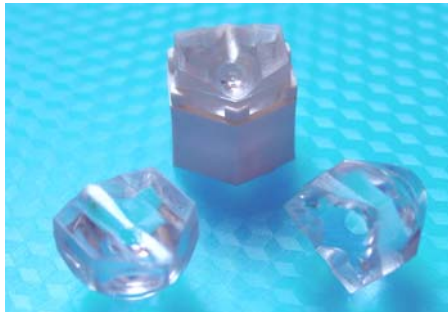

**Diffuse 25 Degree LED Collimator
Part No. 217**

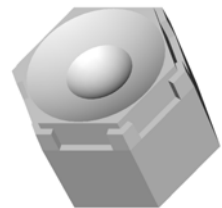

Polymer Optics "Modular LED Optics"[®] design, based on a hexagonal format, allows maximum packing density and assembly flexibility.





Our Focus is in Plastics

Polymer Optics Ltd.

6 Kiln Ride, Wokingham,
Berks., RG40 3JL, England
Tel/Fax: +44 (0) 1189 893341
www.polymer-optics.co.uk

Narrow Angle Nichia 083 Series Colour Mixer Assembly - Part No. 181

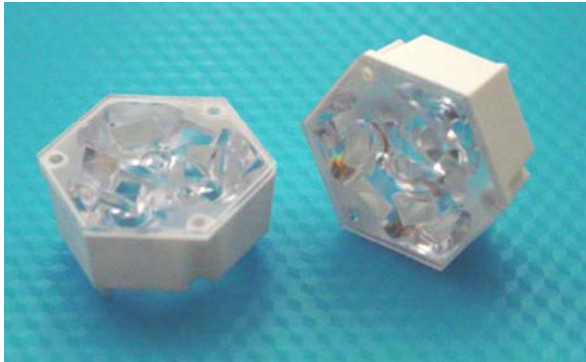

- Designed to work with the new single colour Nichia Rigel 083 series LEDs
- High collection efficiency and narrow angle beam output
- Precision moulded in optical grade Polycarbonate for thermal stability and system durability
- Part of the Polymer Optics “Modular LED Optics”® range

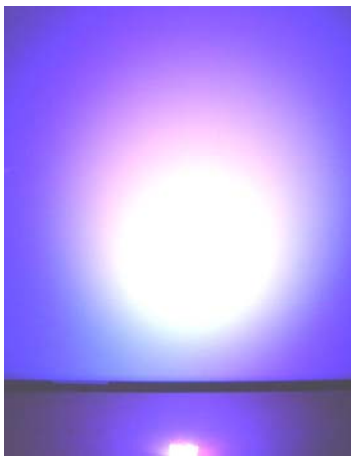

- POL's novel hexagonal design allows the optics to be clustered together to make larger narrow angle colour mixing arrays

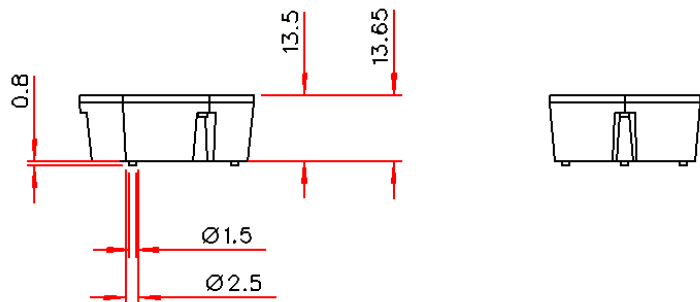
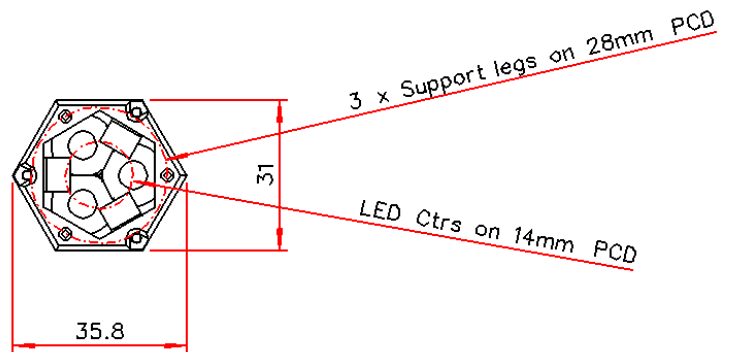
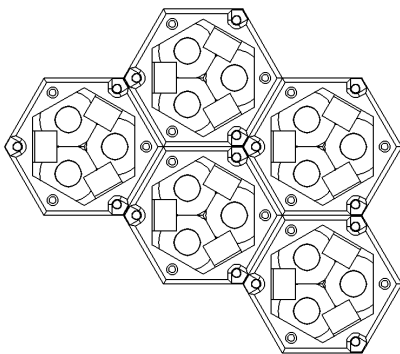

Due to continuous product improvement, POL reserve the right to change specifications without notice.



Our Focus is in Plastics

Polymer Optics Ltd.

6 Kiln Ride, Wokingham,
Berks., RG40 3JL, England
Tel/Fax: +44 (0) 1189 893341
www.polymer-optics.co.uk

Narrow Angle Nichia 083 Series Colour Mixer Assembly - Part No. 181



Red



Green



Blue



Red/Blue



Green/Blue



Red/Green

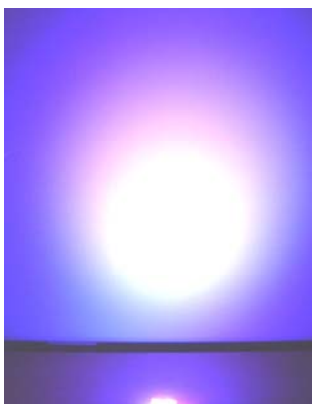

Red/Green/Blue

- Excellent colour mixing performance with single colour LED's even over short distances
- Narrow angle basic beam angle which can be converted to wider beam angles or elliptical profiles with POL converter optics and filters
- Can also be used with White LED's to improve bin mixing and reduce colour temperature variations



Our Focus is in Plastics

Polymer Optics Ltd.

6 Kiln Ride, Wokingham,
Berks., RG40 3JL, England
Tel/Fax: +44 (0) 1189 893341
www.polymer-optics.co.uk

Converter Optics for Narrow Angle LED Colour Mixer Assembly

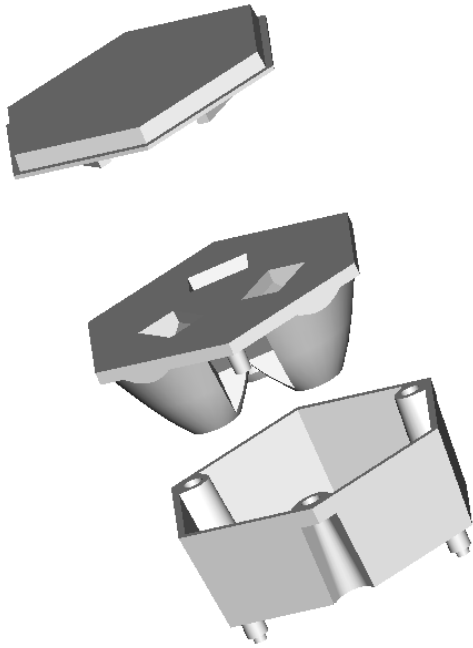

- Beam Converter Optics simply interference push fit onto the front of the 181 - Colour Mixer Optic.
- Precision moulded in optical grade PMMA acrylic for improved scratch resistance on the outside of the assembly.
- The Beam Converter Optics fit within the area of the 181- Colour Mixer Optic so the assemblies can still be arranged in close packed arrays.
- Flanged edge of the Beam Converter Optics allows bezels and cover plates to be located to the optical assembly for aesthetic product finishing.
- Part of the Polymer Optics “Modular LED Optics”[®] range

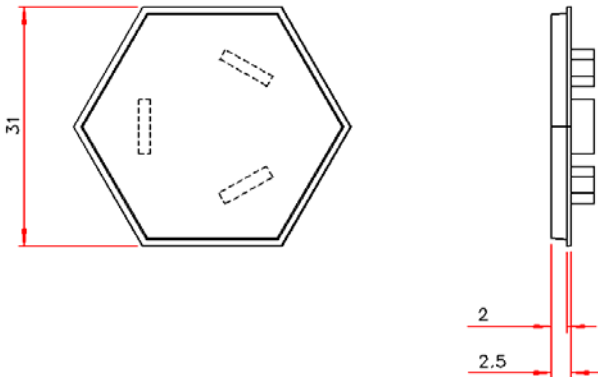



Our Focus is in Plastics

Polymer Optics Ltd.

6 Kiln Ride, Wokingham,
Berks., RG40 3JL, England
Tel/Fax: +44 (0) 1189 893341
www.polymer-optics.co.uk

Converter Optics for Narrow Angle LED Colour Mixer Assembly

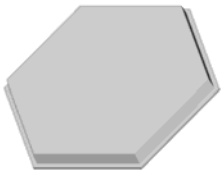

Plain Filter Holder - 160

- 160 - Plain Filter Holder can be used with Luminet Light Shaping Diffuser films to produce a wide range of beam profiles, available from POL or direct from www.luminetco.com.
- Other custom beam angles can be produced cost effectively from POL's modular production tooling. Please enquire for details

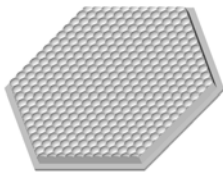

25 Deg Diffuser - 161

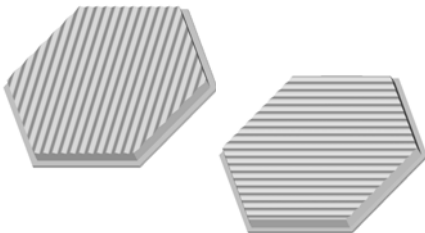

6 x 25 Deg Line Diffusers – 162 & 162B

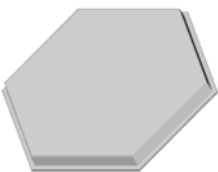
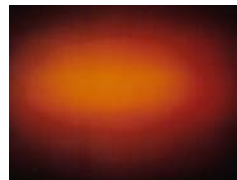

Soft Beam Diffuser - 163





Our Focus is in Plastics

Polymer Optics Ltd.

6 Kiln Ride, Wokingham,
Berks., RG40 3JL, England
Tel/Fax: +44 (0) 1189 893341
www.polymer-optics.co.uk

Converter Optics for Narrow Angle LED Colour Mixer Assembly

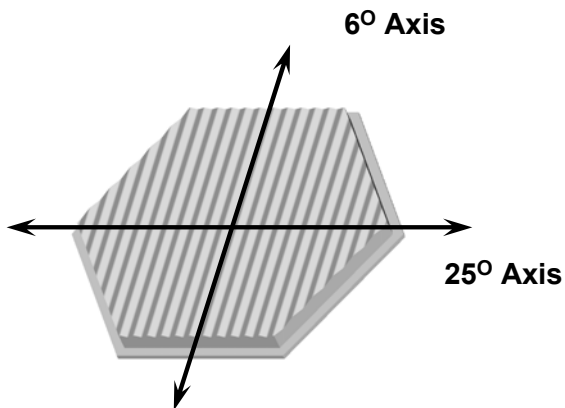

6 x 25 Deg Line Diffusers – 162

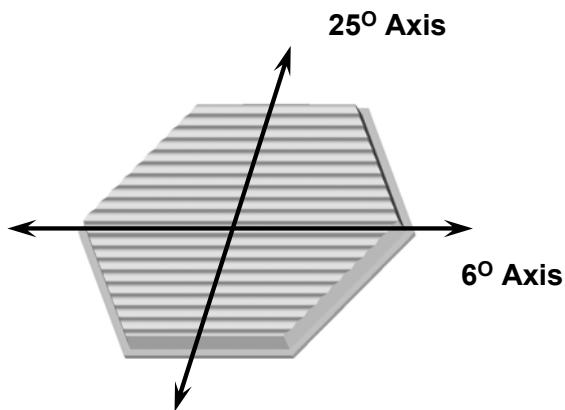

6 x 25 Deg Line Diffusers – 162B

6 x 25 Deg Line Diffusers is available in two versions, the 162 and the 162B

These diffusers have the same optical function, but allow the beam to be spread in either orthogonal direction.

The 162 version can be used where multiple rows of optics are used and a close packed narrow array is required, along the axis of the linear beam output.

The 162B version can be used where single row linear fittings are required with the optics close packed together with the hexagonal flats placed side by side.

These 6 x 25 Deg Line Diffusers can also be mixed in optical arrays to produce other overall beam effects.







Our Focus is in Plastics

Polymer Optics Ltd.

6 Kiln Ride, Wokingham,
Berks., RG40 3JL, England
Tel/Fax: +44 (0) 1189 893341
www.polymer-optics.co.uk

Price List for Nichia 083 Series LED Optic Range

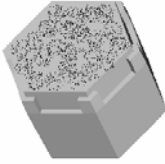
Product Image	Description	Usage	100-1K Batches	1K-5K Batches	5K-10K Batches	10K+ Batches
 120/175	6° Collimator + Holder for Nichia 083 Series	Nichia Rigel single colour and white LEDs	£1.25	£0.98	£0.77	£0.72
 124/175	25° Collimator + Holder for Nichia 083 Series	Nichia Rigel single colour and white LEDs	£1.25	£0.98	£0.77	£0.72
 126/175	6°x25° Line + Holder for Nichia 083 Series	Nichia Rigel single colour and white LEDs	£1.25	£0.98	£0.77	£0.72
 141/175	Single Cell Concentrator Optic + Holder for Nichia 083 Series	Nichia Rigel single colour and white LEDs	£1.25	£0.98	£0.77	£0.72
 185/175	Diffuse 6° Collimator + Holder for Nichia 083 Series	Nichia Rigel single colour and white LEDs	£1.25	£0.98	£0.77	£0.72

*** A minimum order value applies of £50+shipping - All prices “ex-works”
Please contact POL for quotations on higher volumes and custom variants**





Our Focus is in Plastics

Polymer Optics Ltd.

6 Kiln Ride, Wokingham,
Berks., RG40 3JL, England
Tel/Fax: +44 (0) 1189 893341
www.polymer-optics.co.uk

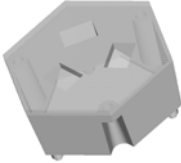
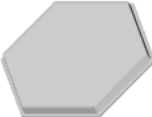
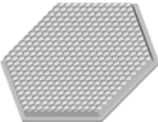
Price List for Nichia 083 Series LED Optic Range

Product Image	Description	Usage	100-1K Batches	1K-5K Batches	5K-10K Batches	10K+ Batches
 181	6° Colour Mixer Collimator Assembly	Nichia Rigel single colour and white LEDs	£3.80	£3.60	£3.20	£3.00
 160	Filter Holder	Fits to 181 Optic	£0.32	£0.30	£0.27	£0.25
 161	25° Beam Converter Optic	Fits to 181 Optic	£0.32	£0.30	£0.27	£0.25
 162	6°x25° Beam Converter Optic	Fits to 181 Optic	£0.32	£0.30	£0.27	£0.25
 162B	6°x25° Beam Converter Optic	Fits to 181 Optic	£0.32	£0.30	£0.27	£0.25

*** A minimum order value applies of £50+shipping - All prices “ex-works”**

Please contact POL for quotations on higher volumes and custom variants







Our Focus is in Plastics

Polymer Optics Ltd.

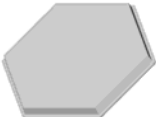
6 Kiln Ride, Wokingham,
Berks., RG40 3JL, England
Tel/Fax: +44 (0) 1189 893341
www.polymer-optics.co.uk

Price List for Nichia 083 Series LED Optic Range

Product Image	Description	Usage	100-1K Batches	1K-5K Batches	5K-10K Batches	10K+ Batches
 163	Beam Diffuser Filter	Fits to 181 Optic	£0.32	£0.30	£0.27	£0.25
 201/175	15° Collimator + Holder for Nichia 083 Series	Nichia Rigel single colour and white LEDs	£1.25	£0.98	£0.77	£0.72
 216/175	Diffuse 6°x25° Line + Holder for Nichia 083 Series	Nichia Rigel single colour and white LEDs	£1.25	£0.98	£0.77	£0.72
 217/175	Diffuse 25° Collimator + Holder for Nichia 083 Series	Nichia Rigel single colour and white LEDs	£1.25	£0.98	£0.77	£0.72

* A minimum order value applies of £50+shipping - All prices “ex-works”

Please contact POL for quotations on higher volumes and custom variants